

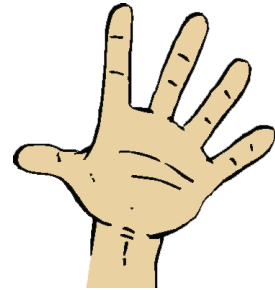

NumberSense
Mathematics Programme



NumberSense
Mathematics Programme



NumberSense
Mathematics Programme

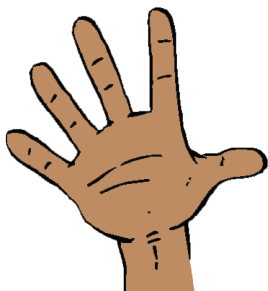

NumberSense
Mathematics Programme



NumberSense
Mathematics Programme

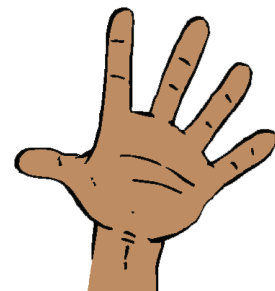

NumberSense
Mathematics Programme



NumberSense
Mathematics Programme









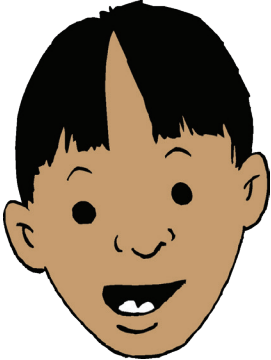

NumberSense
Mathematics Programme



NumberSense
Mathematics Programme

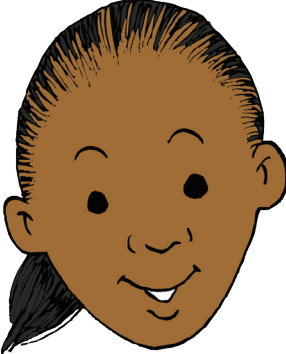

| | | |
|---|---|---|
|  <p>NumberSense Mathematics Programme</p> |  <p>NumberSense Mathematics Programme</p> |  <p>NumberSense Mathematics Programme</p> |
|  <p>NumberSense Mathematics Programme</p> |  <p>NumberSense Mathematics Programme</p> |  <p>NumberSense Mathematics Programme</p> |
|  <p>NumberSense Mathematics Programme</p> |  <p>NumberSense Mathematics Programme</p> |  <p>NumberSense Mathematics Programme</p> |

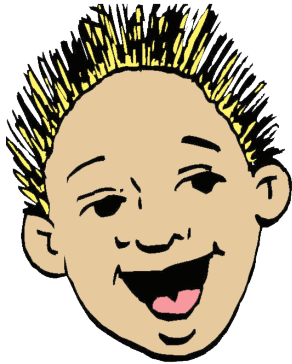

NumberSense
Mathematics Programme



NumberSense
Mathematics Programme



NumberSense
Mathematics Programme



NumberSense
Mathematics Programme

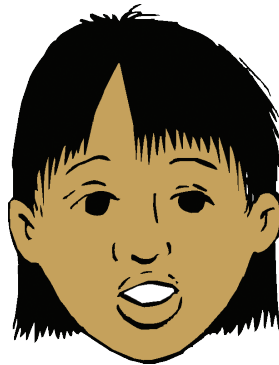

NumberSense
Mathematics Programme

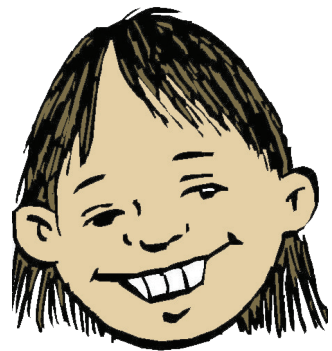

NumberSense
Mathematics Programme



NumberSense
Mathematics Programme

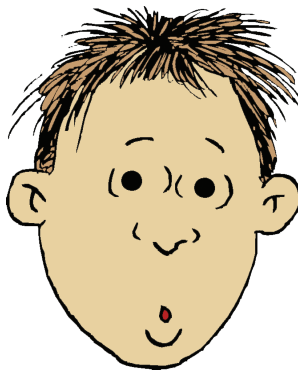

NumberSense
Mathematics Programme



NumberSense
Mathematics Programme

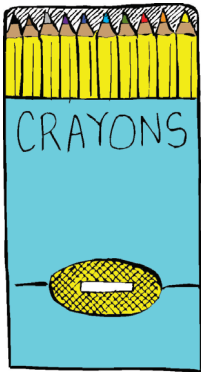

NumberSense
Mathematics Programme



NumberSense
Mathematics Programme

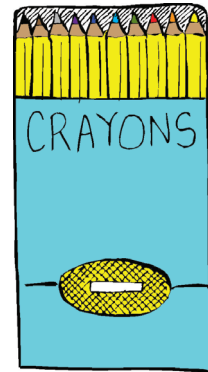

NumberSense
Mathematics Programme

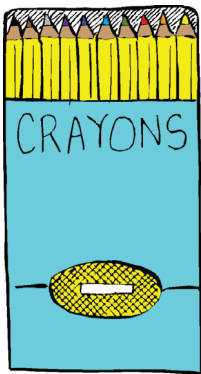

NumberSense
Mathematics Programme

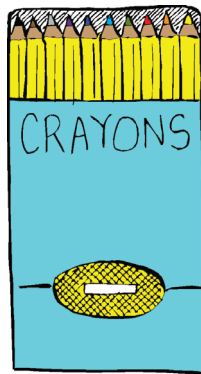

NumberSense
Mathematics Programme

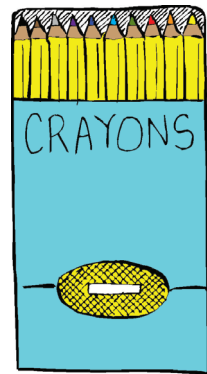

NumberSense
Mathematics Programme

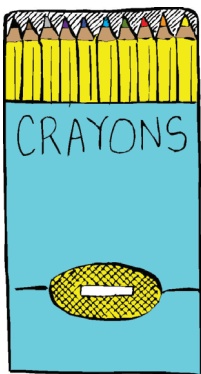

NumberSense
Mathematics Programme

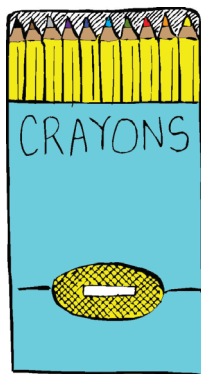

NumberSense
Mathematics Programme

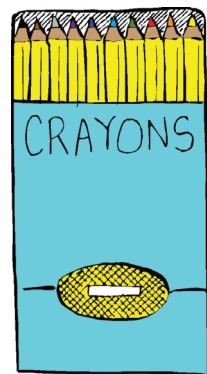

NumberSense
Mathematics Programme

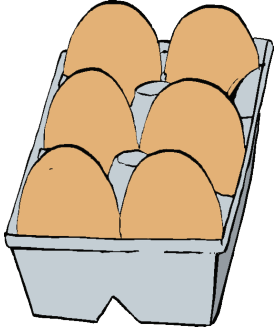

NumberSense
Mathematics Programme

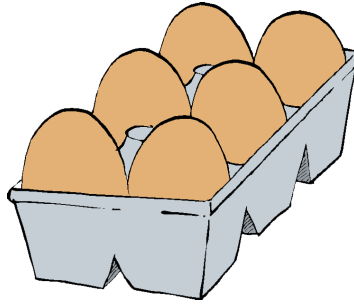

NumberSense
Mathematics Programme

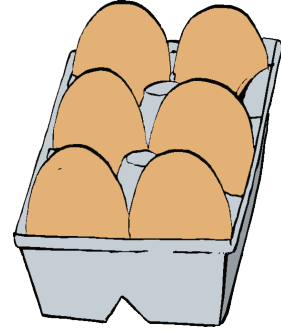

NumberSense
Mathematics Programme

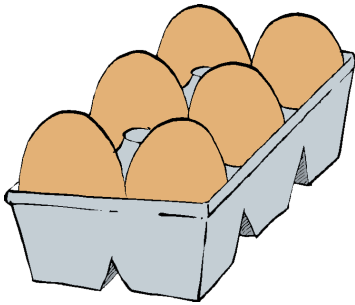

NumberSense
Mathematics Programme

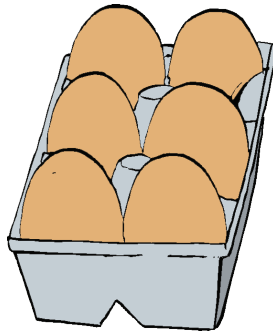

NumberSense
Mathematics Programme

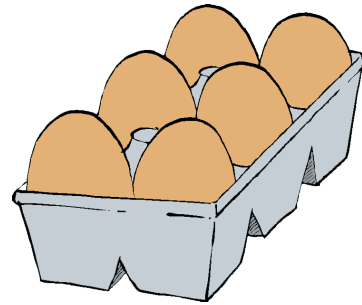

NumberSense
Mathematics Programme

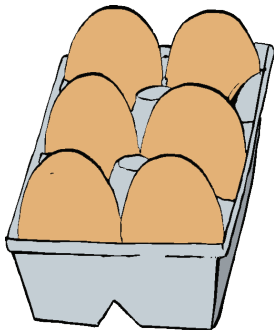

NumberSense
Mathematics Programme

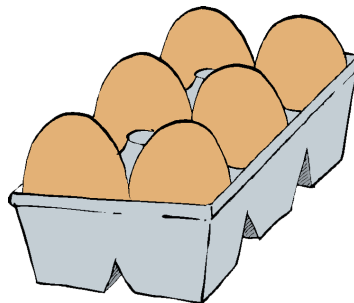

NumberSense
Mathematics Programme

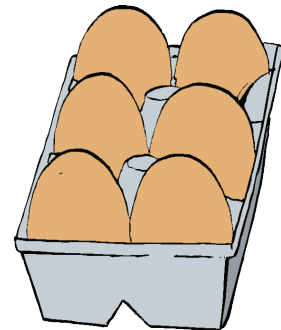

NumberSense
Mathematics Programme

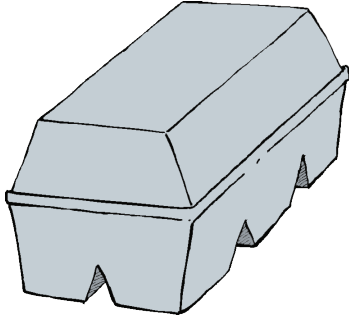

NumberSense
Mathematics Programme

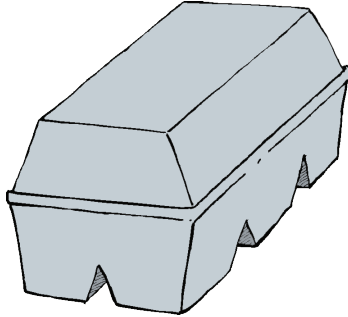

NumberSense
Mathematics Programme

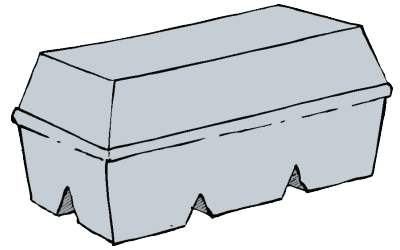

NumberSense
Mathematics Programme

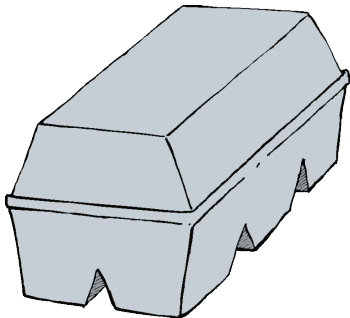

NumberSense
Mathematics Programme

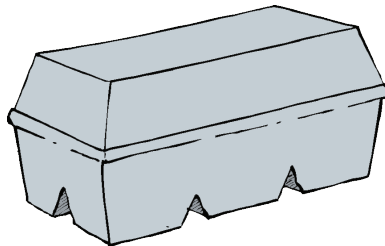

NumberSense
Mathematics Programme

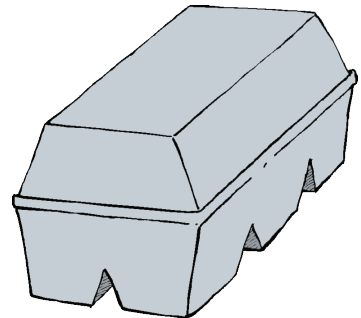

NumberSense
Mathematics Programme

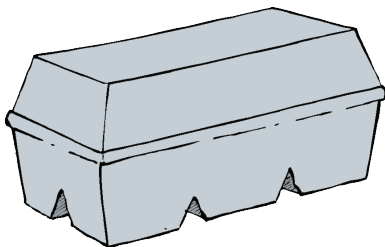

NumberSense
Mathematics Programme

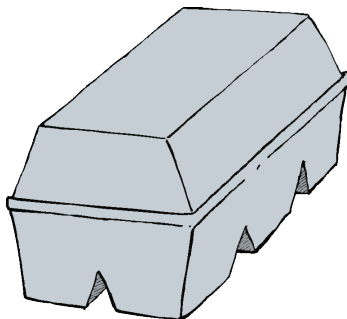

NumberSense
Mathematics Programme

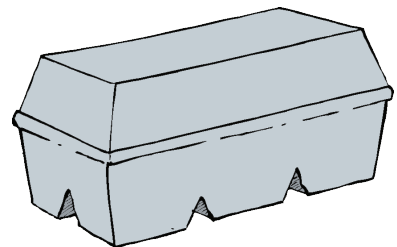

NumberSense
Mathematics Programme



NumberSense
Mathematics Programme



NumberSense
Mathematics Programme



NumberSense
Mathematics Programme



NumberSense
Mathematics Programme



NumberSense
Mathematics Programme



NumberSense
Mathematics Programme



NumberSense
Mathematics Programme



NumberSense
Mathematics Programme



NumberSense
Mathematics Programme

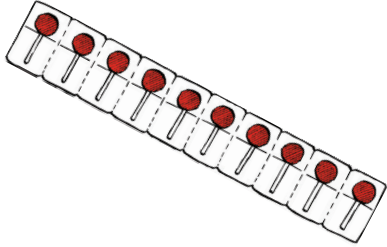

NumberSense
Mathematics Programme

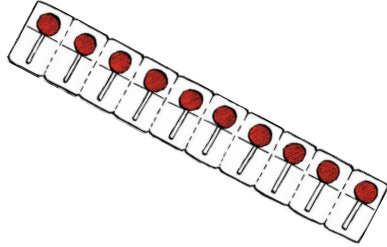

NumberSense
Mathematics Programme

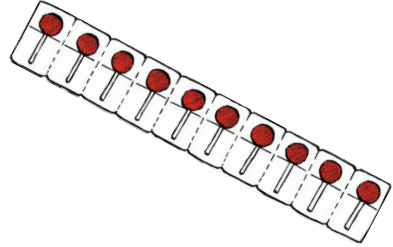

NumberSense
Mathematics Programme

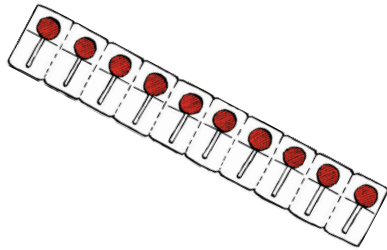

NumberSense
Mathematics Programme

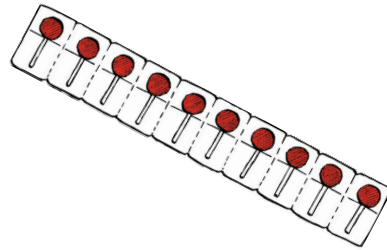

NumberSense
Mathematics Programme

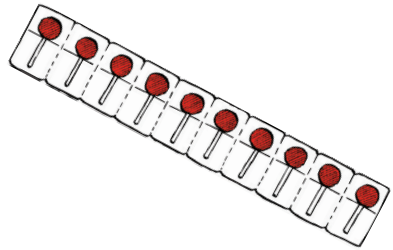

NumberSense
Mathematics Programme

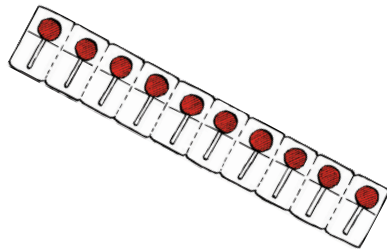

NumberSense
Mathematics Programme

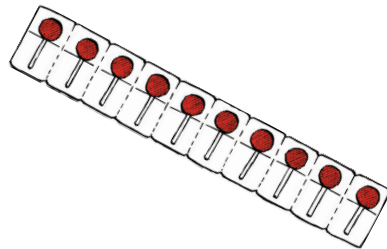

NumberSense
Mathematics Programme

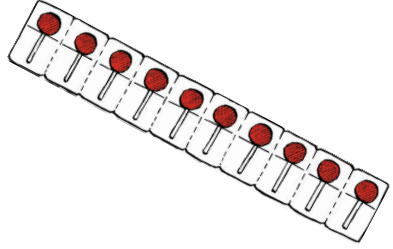

NumberSense
Mathematics Programme

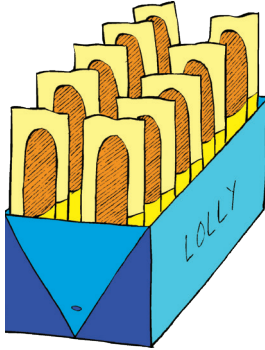

NumberSense
Mathematics Programme

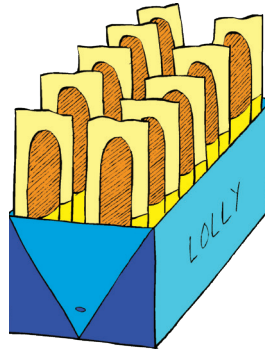

NumberSense
Mathematics Programme

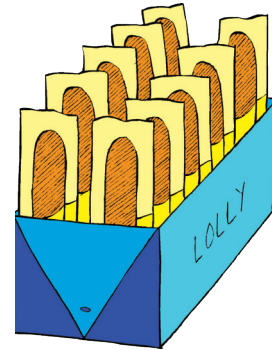

NumberSense
Mathematics Programme

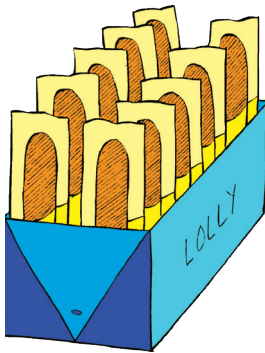

NumberSense
Mathematics Programme

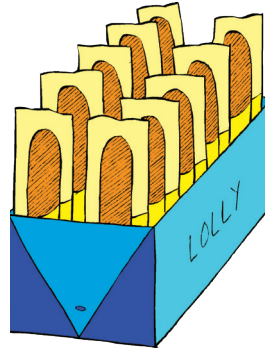

NumberSense
Mathematics Programme

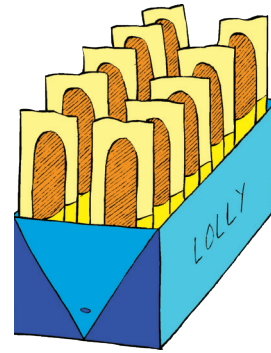

NumberSense
Mathematics Programme

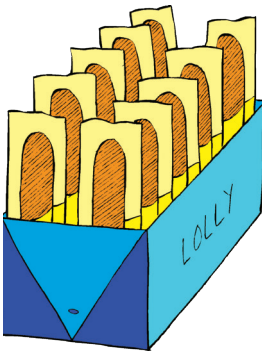

NumberSense
Mathematics Programme

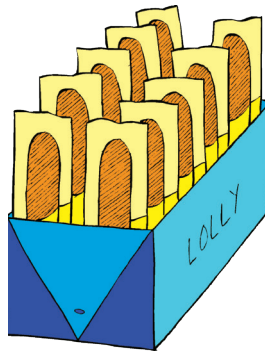

NumberSense
Mathematics Programme

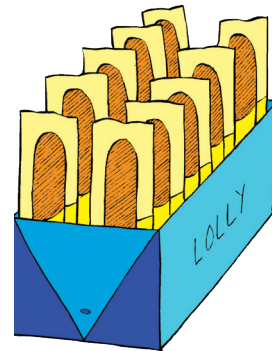

NumberSense
Mathematics Programme

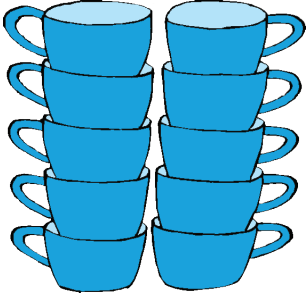
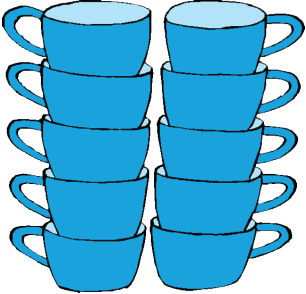
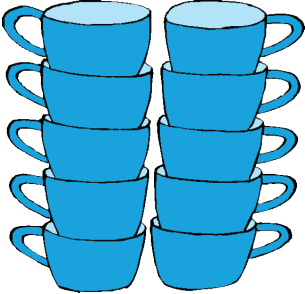
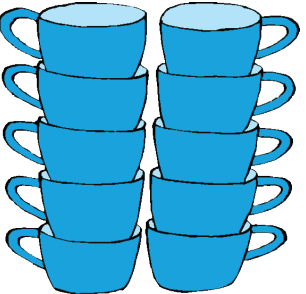
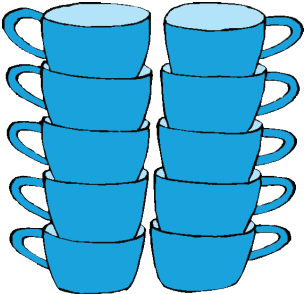
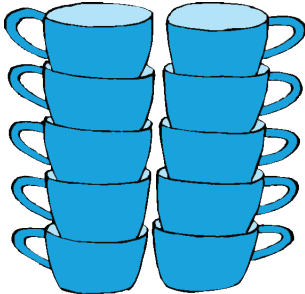
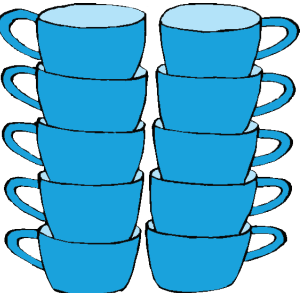
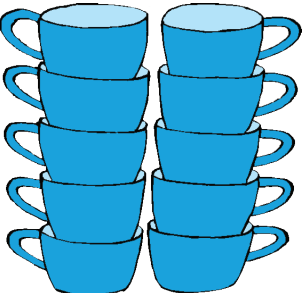
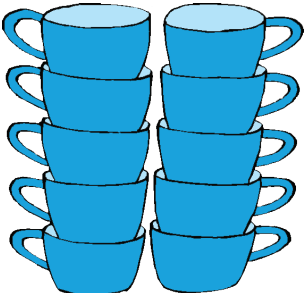

| | | |
|---|---|---|
|  <p>NumberSense Mathematics Programme</p> |  <p>NumberSense Mathematics Programme</p> |  <p>NumberSense Mathematics Programme</p> |
|  <p>NumberSense Mathematics Programme</p> |  <p>NumberSense Mathematics Programme</p> |  <p>NumberSense Mathematics Programme</p> |
|  <p>NumberSense Mathematics Programme</p> |  <p>NumberSense Mathematics Programme</p> |  <p>NumberSense Mathematics Programme</p> |

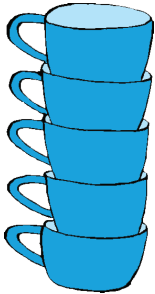

NumberSense
Mathematics Programme

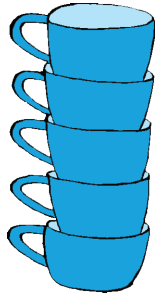

NumberSense
Mathematics Programme



NumberSense
Mathematics Programme

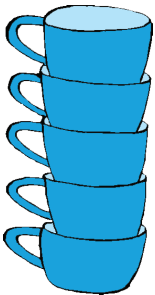

NumberSense
Mathematics Programme

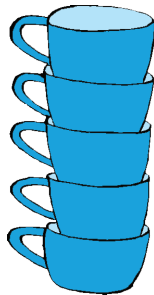

NumberSense
Mathematics Programme



NumberSense
Mathematics Programme

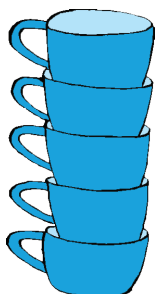

NumberSense
Mathematics Programme



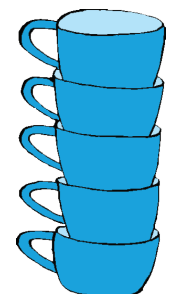

NumberSense
Mathematics Programme



NumberSense
Mathematics Programme

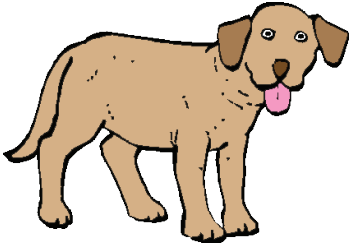
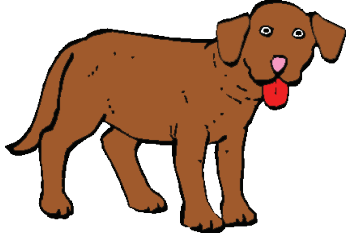
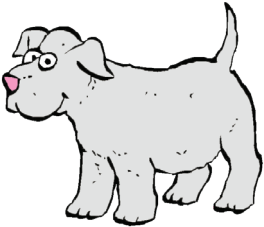
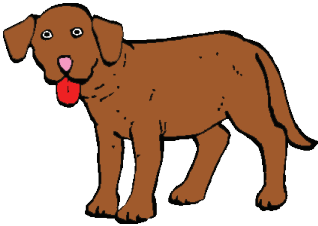
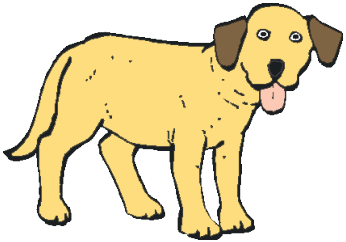
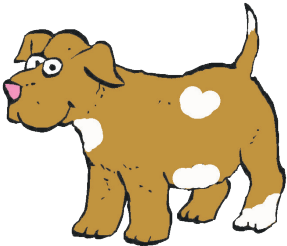

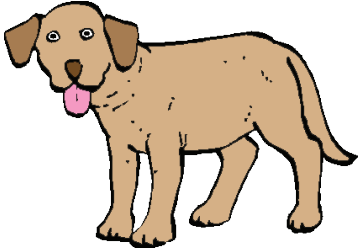
| | | |
|---|---|---|
|  <p>NumberSense Mathematics Programme</p> |  <p>NumberSense Mathematics Programme</p> |  <p>NumberSense Mathematics Programme</p> |
|  <p>NumberSense Mathematics Programme</p> |  <p>NumberSense Mathematics Programme</p> |  <p>NumberSense Mathematics Programme</p> |
|  <p>NumberSense Mathematics Programme</p> |  <p>NumberSense Mathematics Programme</p> |  <p>NumberSense Mathematics Programme</p> |

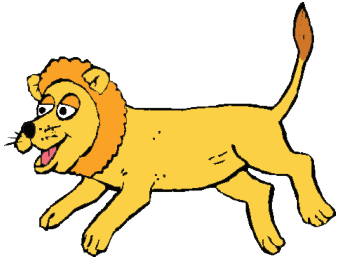

NumberSense
Mathematics Programme

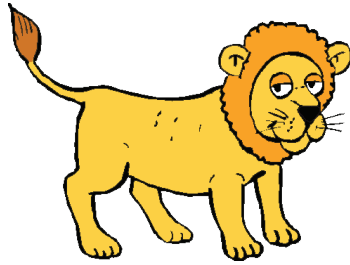

NumberSense
Mathematics Programme



NumberSense
Mathematics Programme



NumberSense
Mathematics Programme

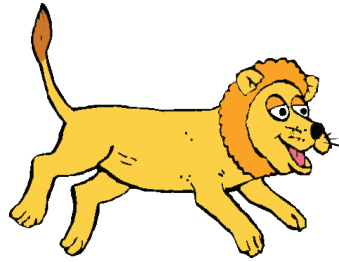

NumberSense
Mathematics Programme

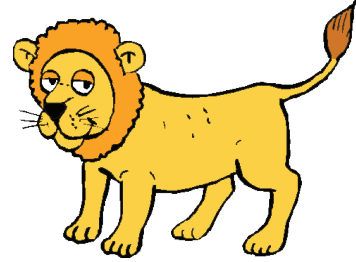

NumberSense
Mathematics Programme

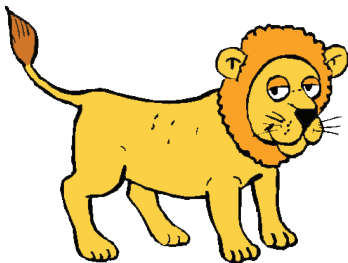

NumberSense
Mathematics Programme



NumberSense
Mathematics Programme

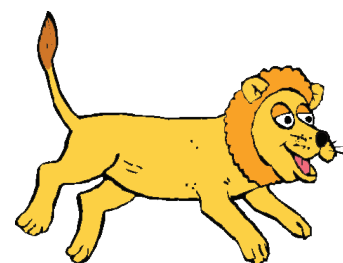

NumberSense
Mathematics Programme



NumberSense
Mathematics Programme



NumberSense
Mathematics Programme



NumberSense
Mathematics Programme



NumberSense
Mathematics Programme



NumberSense
Mathematics Programme



NumberSense
Mathematics Programme



NumberSense
Mathematics Programme



NumberSense
Mathematics Programme



NumberSense
Mathematics Programme